

# Solid Fuel Heating Questionnaire

Clear photos of the heating appliance, flue to chimney connection and an exterior photo of the chimney should accompany this questionnaire.





**Insured's Name:** \_\_\_\_\_ **Ph. #:** \_\_\_\_\_ **Policy #:** \_\_\_\_\_

**Location:** \_\_\_\_\_ **Broker:** \_\_\_\_\_

## WOOD BURNING APPLIANCE

Manufacturer: \_\_\_\_\_ Appliance Type: \_\_\_\_\_  
Model: \_\_\_\_\_ Age: \_\_\_\_\_  
Quantity of Fuel Used: \_\_\_\_\_

Is Appliance Certified? Yes  No

Approved for Mobile Home Yes  No

## APPROVED CLEARANCES AS PER MANUFACTURER'S LABEL OR BROCHURE - Actual measurements to be used on diagram attached.

Sides: \_\_\_\_\_ Back Side: \_\_\_\_\_ Corners: \_\_\_\_\_ Top Side: \_\_\_\_\_  
Above Hot Air Plenum: \_\_\_\_\_ Above first 6 ft. of Hot Air Ducting: \_\_\_\_\_

Floor Protection Left Side: \_\_\_\_\_ Right Side: \_\_\_\_\_ Back of Unit: \_\_\_\_\_ Fueling Door: \_\_\_\_\_

## MASONRY CHIMNEY

Chimney Type Concrete Block  Brick   
Built from Ground  Bracket  Other: \_\_\_\_\_

Chimney Lining Clay Tile  Poured in Place   
None  Factory Certified Stainless Steel  Other: \_\_\_\_\_

Clearance from outer shell of chimney to combustible material: \_\_\_\_\_  
Age of Chimney: \_\_\_\_\_ years  
General Condition Good  Fair  Poor   
Installation Inside Building  Outside Building  Outside Building in an Insulated Enclosure   
Is the chimney clean-out in an easily accessible location? Yes  No

## FACTORY BUILT METAL CHIMNEY

Manufacturer: \_\_\_\_\_  
Certified for wood burning appliances bearing ULC-S629M label (commonly referred to as 2100°) Yes  No   
If No, explain: \_\_\_\_\_  
Clearance from Chimney to Combustible Material: \_\_\_\_\_ inches  
Age of Chimney: \_\_\_\_\_ years  
General Condition Good  Fair  Poor   
Installation Inside Building  Outside Building  Outside Building in an Insulated Enclosure

## GENERAL INSTALLATION QUESTIONS

Are ashes from appliance disposed of in a non-combustible container? Yes  No   
If No, explain: \_\_\_\_\_  
Was the wood heat unit installed by a heating contractor? Yes  No   
Firm or Individual: \_\_\_\_\_  
Was the chimney installed by a heating or masonry contractor? Yes  No   
Firm or Individual: \_\_\_\_\_  
Does the unit share a chimney flue with any other appliance? Yes  No   
If Yes, explain: \_\_\_\_\_  
Does the stove pipe pass through a concealed space? Yes  No   
How often is the chimney cleaned per heating season? \_\_\_\_\_ Date last cleaned: \_\_\_\_\_  
Have any modifications been made? Yes  No  If Yes, explain: \_\_\_\_\_  
Distance from the stove to furniture, fuel or any other combustible materials: \_\_\_\_\_ inches

# Stove Installation

Complete all measurements as per applicable installation on the diagram below. All distances on diagrams are to be measurements taken from the particular installation.

|  |                              |          |
|--|------------------------------|----------|
| Distance from top of stove to ceiling:   |                              | <b>A</b> |
| Distance from stove to nearest side wall:  |                              | <b>B</b> |
| Distance from end of floor protection to stove   |                              |          |
|  | Front:                       | <b>C</b> |
|  | Side:                        | <b>D</b> |
|  | Back:                        | <b>E</b> |
| Distance from stove to back wall:  |                              | <b>F</b> |
| Total length of stovepipe:   |                              | <b>G</b> |
| Is there a thimble/chimney connector where stovepipe passes through the wall or ceiling? |                              |          |
|  | Yes <input type="checkbox"/> | <b>H</b> |
|  | No <input type="checkbox"/>  |          |
| Distance from stovepipe to wall:   |                              | <b>I</b> |
| Distance from stovepipe to ceiling:  |                              | <b>J</b> |

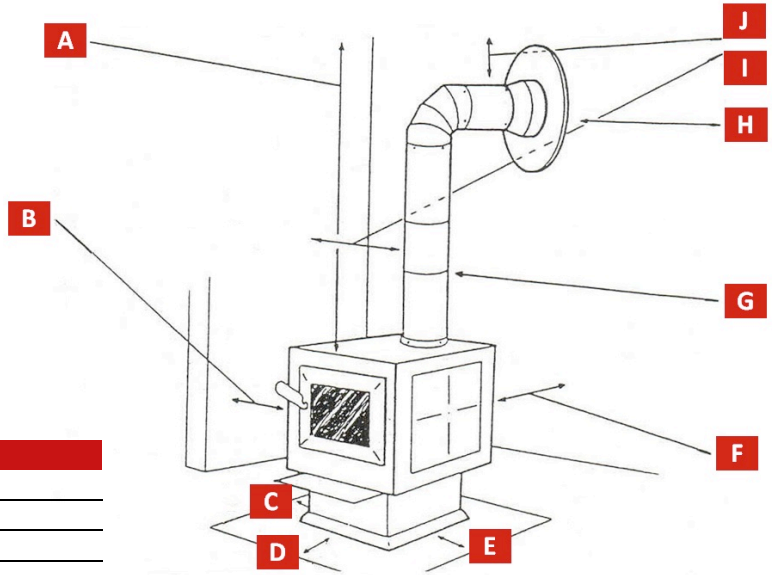

## DESCRIBE CONSTRUCTION OF THE FOLLOWING

Nearest Side Wall: \_\_\_\_\_  
 Floor: \_\_\_\_\_  
 Ceiling: \_\_\_\_\_  
 Back Wall: \_\_\_\_\_

Is there a non-combustible floor pad? Yes  No  Type of floor protection: \_\_\_\_\_

## CONSTRUCTION OF STOVEPIPE

Galvanized  Black Steel  Single Wall  Double-Lined

## SHIELDING

Is installation shielded? Yes  No  Distance from wall to shield: \_\_\_\_\_  
 Type & Thickness of Shielding: \_\_\_\_\_ Construction of Spacers: \_\_\_\_\_  
 Draw shield on diagram above including distances the shield extends beyond the stove in all directions.

# Furnace Installation

|   |                              |          |
|---|------------------------------|----------|
| Distance from hot air ducting to floor joists for first 6 feet:                   |                              | <b>A</b> |
| Distance from hot air plenum to floor joists:                                     |                              | <b>B</b> |
| Distance from cold air plenum to floor joists:                                    |                              | <b>C</b> |
| Distance from cold air ducting to floor joists for first 6 feet:                  |                              | <b>D</b> |
| Distance from stovepipe to ceiling:   |                              | <b>E</b> |
| Is there an insulated thimble where stovepipe passes through the wall or ceiling? |                              |          |
|   | Yes <input type="checkbox"/> | <b>F</b> |
|   | No <input type="checkbox"/>  |          |
| Distance from stovepipe to wall:  |                              | <b>G</b> |
| Distance from front of furnace to a combustible wall:                             |                              | <b>H</b> |
| Distance from furnace to nearest side wall:                                       |                              | <b>I</b> |
| Distance from furnace to back wall:   |                              | <b>J</b> |

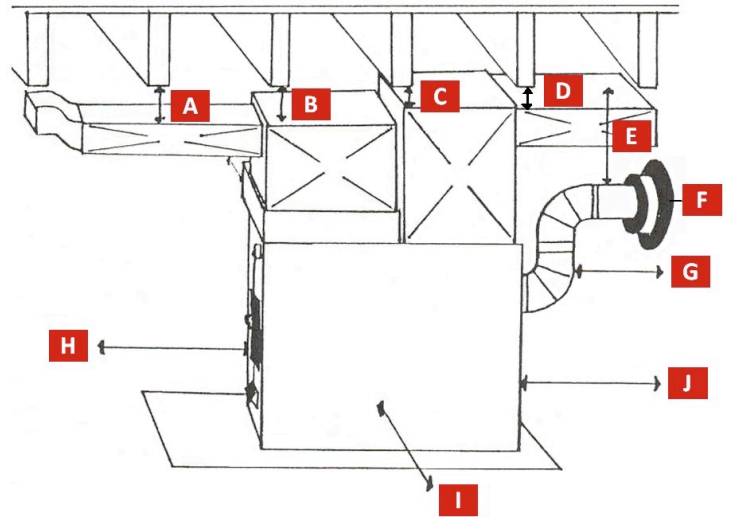

Total length of stovepipe: \_\_\_\_\_  
 Distance from end of floor protection to the furnace Front: \_\_\_\_\_ Side: \_\_\_\_\_ Back: \_\_\_\_\_

## DESCRIBE CONSTRUCTION OF THE FOLLOWING

Ceiling: \_\_\_\_\_ Back Wall: \_\_\_\_\_  
 Is there a non-combustible floor pad? Yes  No  Type of floor protection: \_\_\_\_\_  
 Stovepipe Construction Galvanized  Black Steel  Single Wall  Double-Lined

## SHIELDING

Is installation shielded? Yes  No  Distance from wall/ceiling to shield: \_\_\_\_\_  
 Type & Thickness of Shielding: \_\_\_\_\_ Construction of Spacers: \_\_\_\_\_

## COMMENTS:

DATE OF INSPECTION: \_\_\_\_\_

COMPLETED BY: \_\_\_\_\_